



CPA Touch screen panel

Part No: 90000409

Use, maintenance and installation manual



1. Content

1. Content	2
2. Equipment operation - CPA controller.....	3
3. Capacity settings.....	3
4. Operating modes of the unit	4
4.1. Description of controls	5
4.1.1 Basic menu	5
4.1.2 "MODE" menu (operating mode)	6
4.1.3 "PROGRAMME" menu (weekly programme)	6
4.1.4 "PARTY" and "HOLIDAY" menu (temporary operating modes)	6
4.1.5 "RE-HEATING" menu (air re-heating).....	7
4.2. User system settings.....	7
4.2.1 "FILTER" menu	7
4.2.2 "TIME" menu.....	7
4.2.3 "INPUTS" menu	8
4.2.4 "SWITCH" menu (binary input DI1)	8
4.2.8 "SENSOR" menu (analogue input IN1).....	8
4.2.6 "LIMIT" menu	9
4.2.7 "TEMPERATURE" menu	9
4.2.8 "DISPLAY" menu.....	9
4.2.9 "LANGAUGE" menu	9
4.2.10 Automatic ventilation modes.....	9
4.2.11 Constant duct pressure control.....	10
4.2.12 Warning messages	10
Description of fault messages and their causes	11

2. Equipment operation - CPA controller

As standard the equipment is operated using a CPA touch-screen display controller.

Description of functions:

- Controls are divided into a user part and a servicing part (accessible only to service technicians).
- Ventilation capacity adjustable in a range between 0 and 100%.
- An option to start electric or water air heater and a shut-off damper servo drive.
- Manual mode control or control via independent weekly programmes for ventilation capacity and air heating.
- Extra operating modes "Party" (a temporary capacity boost) and "Holiday" (ventilation switched off temporarily).
- An automatic ventilation control option according to external sensors (air quality, CO2, relative humidity etc.).
- An option of automatic ventilation control with constant pressure in the supply duct.
- An option to increase ventilation capacity through external switches, e.g. in the bathroom or toilet.
- A maximum / minimum ventilation capacity limit option.
- Current room temperature and operating mode display.
- Air filter change alerts.

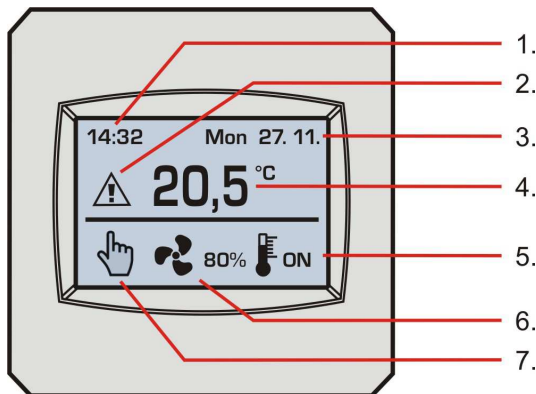

Display:

1. Time
2. Alerts (e.g. filter change necessary)
3. Date
4. Current room temperature
5. Air heating indication (if a heater is included in the system)
6. Ventilation capacity setting in %
7. Operating mode selected

Description of controls:

- Short press – general control and parameter settings
- Long press (3 seconds) of the ventilation capacity symbol – quick ON / OFF
- Long press (5 seconds) at the top of the display – entering the Service Menu







3. Capacity settings

During programming and control using the CPA controller the capacity is set (shown) in percentages of the maximum. The table shows informative air flow rates (m³/hour); they may vary according to the duct system.

Entro	Off	0	10%	20%	30%	40%	50%	60%	70%	80%	90%	100%
DV250	OFF	Unit responds to sensors and external inputs	20	35	95	120	155	180	200	220	240	250
DV300	OFF	Unit responds to sensors and external inputs	20	40	110	160	200	230	250	275	305	315
DV400	OFF	Unit responds to sensors and external inputs	30	50	140	200	260	300	320	350	380	400

4. Operating modes of the unit

The HVAC unit runs in the following modes depending on settings by the controller, the switching of external switches from the bathroom, toilet or kitchen, and air quality sensors:

Mode displayed	Description	Suitable use <i>(data may vary depending on national regulations)</i>
	"Manual mode" – a standard ventilation mode; the unit's ventilation capacity is as per settings.	Permanent ventilation during occupancy, with the capacity to be set at outdoor temperatures of:
	"Weekly programme" – a standard ventilation mode; the unit's ventilation capacity is as per parameters in the time schedule.	<ul style="list-style-type: none"> • more than -5°C to approx. 25 m³/hour/person • less than -5°C to approx. 20 m³/hour/person
	"Automatic mode" – the ventilation capacity is set according to an active external input (e.g. the user's request from the toilet) or air quality, CO ₂ and humidity sensors etc. (if installed).	The unit switches to these modes automatically if any current ventilation capacity requirement is higher than the capacity set in manual mode or the weekly programme.
	"Ventilation run-down" – A temporary ventilation mode which stops automatically after the time set has elapsed.	The unit switches to this mode automatically after any external request has finished (if ventilation run-down time is set).
	The "Party" mode is temporary and stops automatically according to the time set.	A temporary mode for the less common kinds of use of the building such as big parties (higher ventilation capacity required).
	The "Holiday" mode is temporary and stops automatically according to the date and time set; after that the weekly programme is activated automatically.	A temporary mode for the less common kinds of use of the building such as leaving for a holiday (the unit OFF requirement).

4.1. Description of controls

The unit's operating modes can be changed by selecting functions and parameters in relevant menus using the touch-screen display.

The required selection (a function or parameter change) in each menu must be confirmed by pressing the "OK" symbol or one of the "arrow" symbols to move to another menu. If the "Esc" symbol is pressed, the selection is ignored, with a subsequent automatic return to the basic (information) menu.

Note - The CPA controller display is dimmed when idle (displaying); the first touch automatically activates the display's backlight, with follow-up touches already controlling each function (see the description below).

4.1.1 Basic menu

- Operating mode selection
- Ventilation capacity or operation OFF / ON selection
- Starting air re-heating (if an air re-heater is fitted in the system)

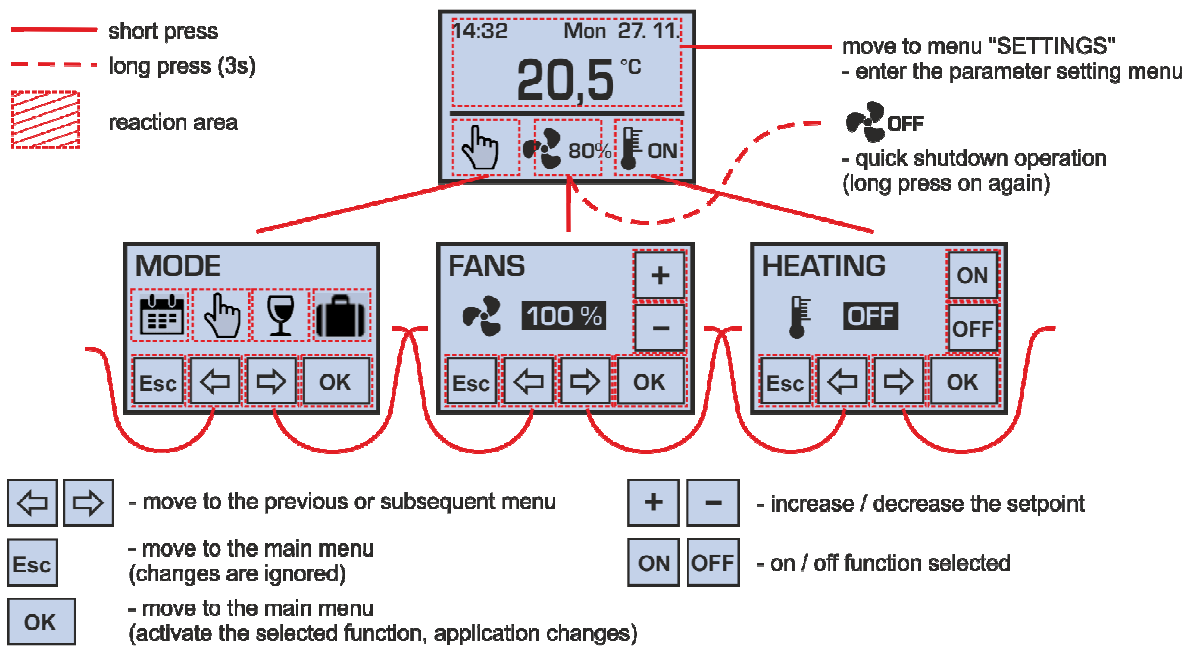

If operation is switched off by setting the ventilation capacity to "OFF", the unit does not respond to external requests, i.e. switches in the bathroom, toilet and kitchen and the air quality sensor are ignored.

If capacity is set to "0%", the fans stop running and the unit does not ventilate. However, unlike with the "OFF" setting, automatic ventilation start based on external requests is still active in this mode.

Note - If nothing has been pressed for a long time in one of the sub-menus, the CPA controller automatically switches to the basic menu.

4.1.2 "MODE" menu (operating mode)

- Weekly programme / manual mode / Party mode / Holiday mode selection

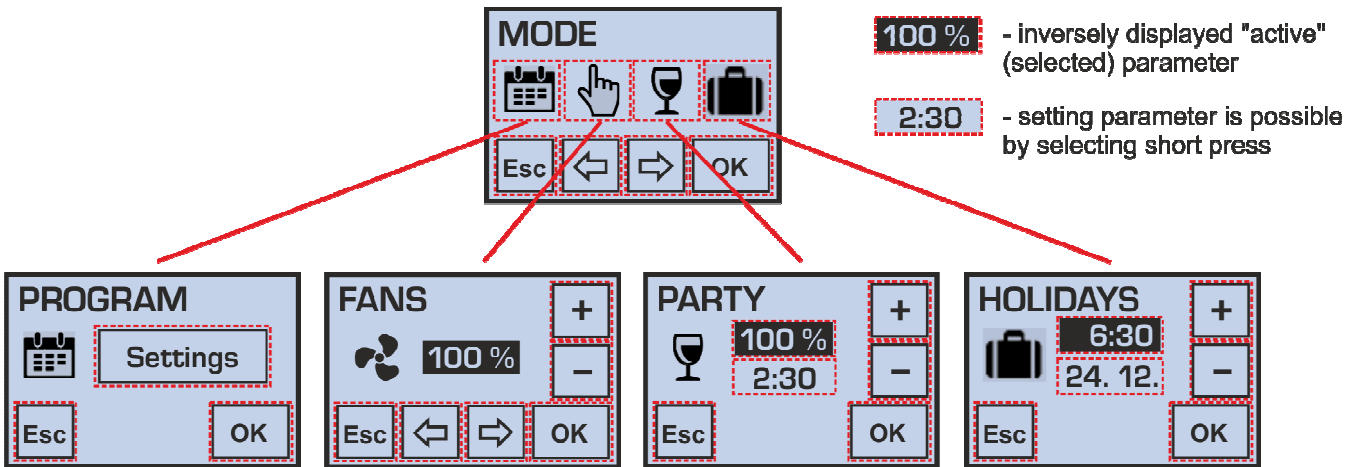

If more parameters are shown in the menu, you can switch between them by a short press; the value of a parameter can then be set by repeatedly pressing the "+" and "-" symbols (setting is faster if a symbol is held).

4.1.3 "PROGRAMME" menu (weekly programme)

- Setting a ventilation capacity weekly programme (time schedule)
- Setting a weekly programme for starting air re-heating

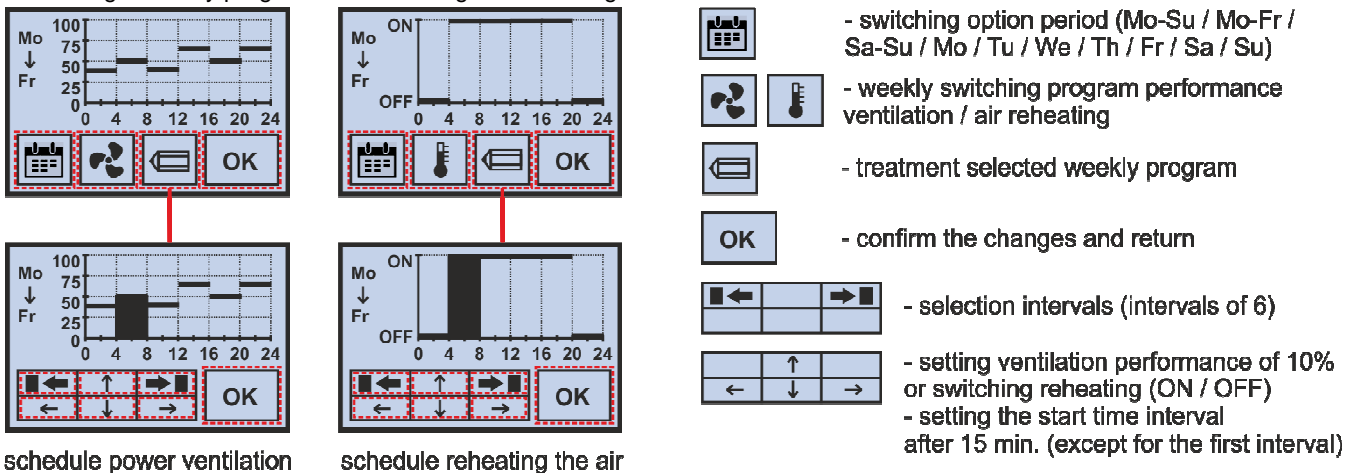

Changes made in the weekly programme for periods **Mon-Sun**, **Mon-Fri** and **Sat-Sun** will apply in all selected days; changes made for **Mon, Tue, Wed, Thu, Fri, Sat** and **Sun** will apply only on the concrete day selected.

! If one or more days of the week have been set individually, the values for these days will be subsequently again rewritten according to the new settings when periods Mon-Sun, Mon-Fri, Sat-Sun and the editing mode (pencil symbol) are selected.

4.1.4 "PARTY" and "HOLIDAY" menu (temporary operating modes)

- Setting the required ventilation capacity in Party mode in a range between 20 and 100%
- Setting the duration of the Party mode in a range between 10 minutes and 5 hours
- Setting the time and date of ending the Holiday mode

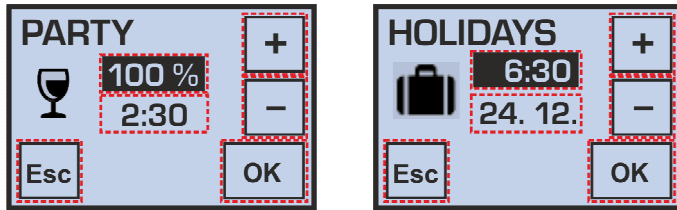

After the Party mode has ended, the unit automatically returns to the operating mode selected previously; after the Holiday mode has ended, the unit automatically switches to the operating mode currently selected according to the weekly programme.



Note - Both Party and Holiday modes can be stopped early by selecting another operating mode.

4.1.5 "RE-HEATING" menu (air re-heating)

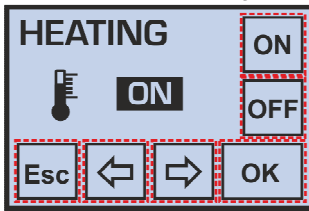
- Starts air re-heating in manual mode



This menu is accessible only if an electric or water air re-heater is fitted (a selection in the service menu).

Air re-heater operation information is indicated in the basic menu by  and .

Note - Air re-heating using an electric heater is subject to ventilation running at a minimum of 30% of its capacity in order to ensure an air flow rate sufficient for cooling the heating elements down.

The red light with the symbol on the front of the HVAC unit's control module coming on indicates active anti-freeze protection of the hot-water air heater (i.e. ventilation is force-stopped).

4.2. User system settings

Movement arrows   allow moving between user menus:

MODE / VENTILATION / RE-HEATING / FILTER / TIME / SETTING

Pressing the OK button in the "SETTING" menu provides access to other parameter menus:

INPUTS / SWITCH / SENSOR / SENSOR / LIMIT / TEMPERATURE / DISPLAY / FIRMWARE / LANGUAGE / LANGUAGE / LANGUAGE

ATTENTION – Inappropriate parameter settings may have a negative effect on the correct function of the equipment!

4.2.1 "FILTER" menu

- Indication of the number of days left until a filter change is required
- Setting a regular filter change interval between 30 and 150 days (in 10 day increments)
- Filter change confirmation (after confirmation a new countdown is automatically started)

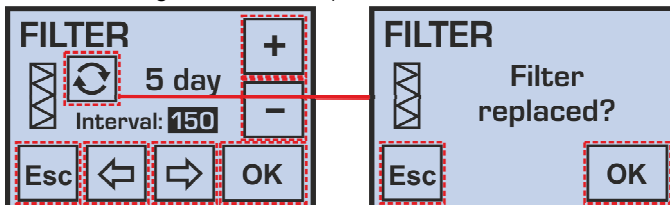

The regular filter change interval should be set according to the dust and pollen loads of the outdoor environment.

4.2.2 "TIME" menu

- Setting the current time
- Selecting the 12 /24 hour time format

- Setting the current date

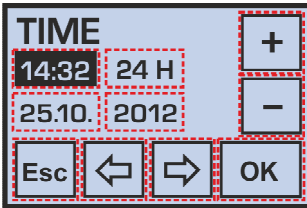

Note - An automatic shift between daylight saving time and standard time is not supported and must be done manually.

4.2.3 “INPUTS” menu

- An option to allow / disallow the increased ventilation capacity function
 - Binary DI1 input for connecting external voltage-free switches
- An option to allow / disallow the automatic ventilation capacity control function according to the concentrations of quantities measured
 - Analogue input IN1 for connecting an external sensor (sensor “S”) with a 0-10V signal output to detect air quality, CO₂ concentration, relative humidity etc.

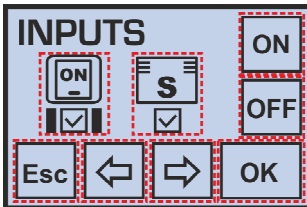

4.2.4 “SWITCH” menu (binary input DI1)

- Setting ventilation capacity with the DI1 input closed in a range between 10 and 100%
- Setting a function’s start-up delay time in a range between 0 – 300 seconds (in 10 second increments)
- Setting a function’s run-down time in a range between 0 – 300 seconds (in 10 second increments)

If the button is used, the start-up delay time must be set to “0 seconds” (for a short press of the button to be accepted) and the run-down time must be set to a non-zero value.

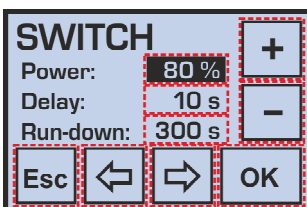

4.2.8 “SENSOR” menu (analogue input IN1)

- Setting the ventilation capacity dependency curve on the level of the 0-10V signal from an external sensor

This function allows adjusting the unit’s suitable response (ventilation capacity) to a gradual increase in the concentration of a quantity measured (e.g. for economic or noise reasons).

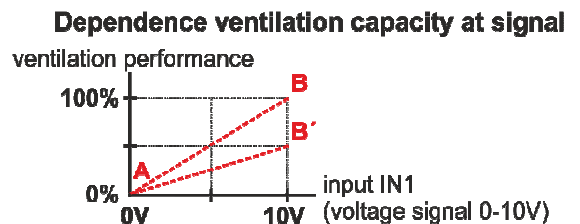
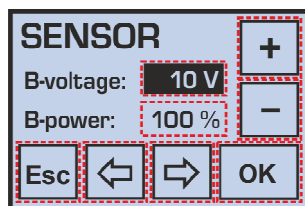
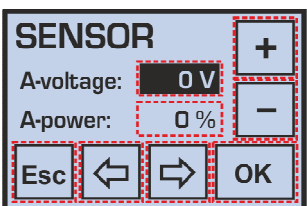

Setting the “inversion” response of ventilation capacity control to the 0-10V control signal (i.e. the opposite slope of the A - B curve).

This function can also be used to connect a sensor with a different output voltage range (e.g. 0-5V, 2-10V).

4.2.6 “LIMIT” menu

- Setting maximum and minimum permitted ventilation capacities
- An option to allow / disallow the function of stopping operation (ventilation capacity = OFF)

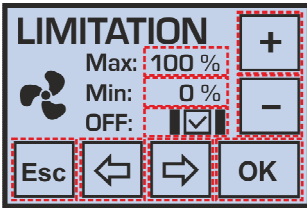

Attention – Settings in the “LIMIT” menu subsequently affects (limits) all operating modes and parameter settings in other user menus.

If the parameter “Min:” is set to a non-zero value, the unit can be switched off just by a long press (3 seconds) of the ventilation symbol in the basic menu or manually selecting ventilation capacity OFF (if allowed).

4.2.7 “TEMPERATURE” menu

- Setting the calibration of the internal air temperature sensor in a range of +/- 3°C (in 0.5°C increments)

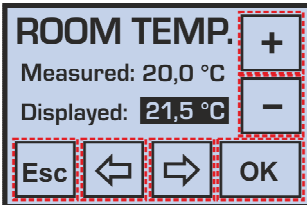

4.2.8 “DISPLAY” menu

- Setting the brightness and contrast of the display (recommended values 70% and 50%)

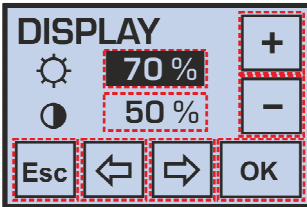

4.2.9 “LANGAUGE” menu

- Menu language selection



Note - When the controller has been disconnected from power supply for more than 48 hours, the language is automatically set to English upon reconnecting.

4.2.10 Automatic ventilation modes

If the operating mode indicated differs from the mode set manually by the user or the weekly programme, the appliance's operation (ventilation capacity) at the time is influenced by an external request – a contact or analogue input (sensor).

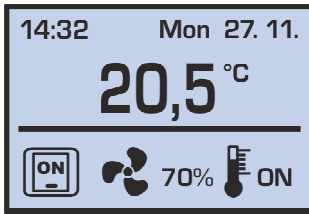

- A request from a switch in the bathroom / toilet / kitchen humidity sensor

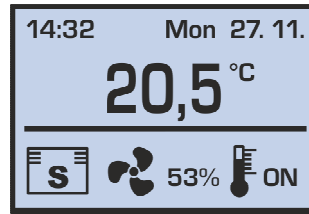

- A request from an air quality / CO₂ / relative

4.2.11 Constant duct pressure control

If the unit is running in constant supply duct pressure control mode (settings in the service menu), the "VENTILATION" and "PROGRAMME" menus offer the following options: OFF / 0% / ☾ / ☀.



The "sun" and "moon" symbols represent two possible levels of required pressure; ☀ is a regular operating (daily) pressure value, ☾ indicates a low pressure level designed for reduced nightly operation (e.g. due to noise).

This special mode in conjunction with a duct pressure sensor is able to ensure automatic ventilation capacity control according to a changeable number of rooms to be ventilated in the building (e.g. centralised ventilation in a block of flats).

Note - If a problem occurs during operation with measuring pressure in the supply duct (e.g. due to a pressure sensor defect), the constant pressure capacity control mode can be deactivated in the user menu "INPUT" by cancelling the CS function ("constant sensor").

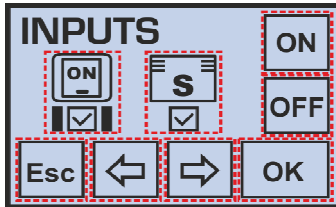

Ventilation capacity can now be controlled in a usual manner in manual mode or according to weekly programme settings (see the description on chapters 4.1.1. a 4.1.3.).

4.2.12 Warning messages

During operation the controller may show warning messages indicating a need to replace an air filter or empty batteries; in case of a defect of the appliance, a warning message is shown recommending that a servicing department should be contacted.

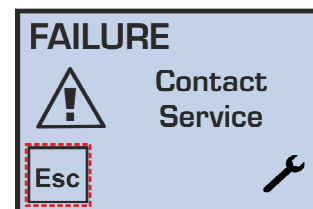
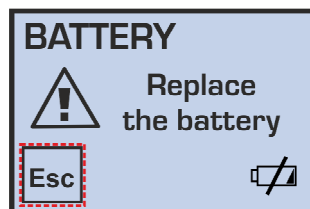
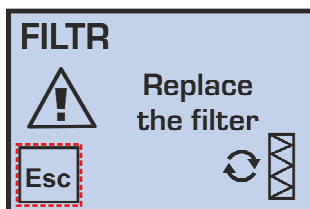

Replacing the controller battery:

Before replacing the battery disconnect the appliance from power supply!

Subsequently use a tool (e.g. a flat screwdriver) to apply pressure to release the "lock" at the bottom of the controller and remove the front part with the display. The CR1632 battery can now be replaced and both parts of the controller put back together. After switching it on it is necessary to set the correct time and date.

Description of fault messages and their causes

Fault	Description	Possible cause	Troubleshooting
The equipment cannot be started	<ul style="list-style-type: none"> The equipment remains idle even after the required performance level was selected 	<ul style="list-style-type: none"> Power supply is not connected 	<ul style="list-style-type: none"> Connect the equipment to power supply (switch on upstream safety circuit breakers)
		<ul style="list-style-type: none"> Not found 	<ul style="list-style-type: none"> Disconnect from power supply and contact a service technician
The equipment is not supplying enough air	<ul style="list-style-type: none"> The equipment is providing a significantly lower volume of air 	<ul style="list-style-type: none"> Blocked filter 	<ul style="list-style-type: none"> Disconnect the equipment from power supply Replace the filter cloth or cassette If the equipment has been in operation for more than approx. 4 years, clean the heat recovery exchanger/s
		<ul style="list-style-type: none"> A mechanical obstacle at fresh air suction or supply air outlets 	<ul style="list-style-type: none"> Check whether the suction openings of fresh air or supply air outlets are not mechanically covered Remove any obstacles Visually and by listening check whether the dampers open properly
		<ul style="list-style-type: none"> Not found 	<ul style="list-style-type: none"> Disconnect from power supply and contact a service technician
The equipment is not heating or is heating insufficiently	<ul style="list-style-type: none"> When the heater has been started, supply air continues to be cold 	<ul style="list-style-type: none"> The electric heater is not connected to power supply 	<ul style="list-style-type: none"> Connect the equipment to power supply (switch on upstream safety circuit breakers) – can only be done by an authorized person
		<ul style="list-style-type: none"> Response of the electric heater's heat protection 	<ul style="list-style-type: none"> Wait to see if the fault does not sort itself out after approx. 1 hour
		<ul style="list-style-type: none"> Low maximum capacity of the heater 	<ul style="list-style-type: none"> Does not constitute a fault (insufficient capacity designed)
		<ul style="list-style-type: none"> Not found 	<ul style="list-style-type: none"> Disconnect from power supply and contact a service technician
Water is dripping from the equipment	<ul style="list-style-type: none"> Water droplets form between the door and body of the equipment during operation 	<ul style="list-style-type: none"> The condensate drain siphon is insufficiently flooded 	<ul style="list-style-type: none"> Disconnect the equipment from power supply and flood the condensate drain siphon
		<ul style="list-style-type: none"> The condensate drain is blocked with dirt 	<ul style="list-style-type: none"> Disconnect the equipment from power supply and clean the condensate drain including the siphon
		<ul style="list-style-type: none"> The seal groove is damaged (the fault can be accompanied by a whistling sound caused by air flowing through the gap) 	<ul style="list-style-type: none"> Disconnect the equipment from power supply and replace the seal
	<ul style="list-style-type: none"> Water droplets form at the condensate drain connection point 	<ul style="list-style-type: none"> The condensate drain seal or line is damaged 	<ul style="list-style-type: none"> Disconnect the equipment from power supply and re-seal the condensate drain
		<ul style="list-style-type: none"> Not found 	<ul style="list-style-type: none"> Disconnect from power supply and contact a service technician

Call: 01494 525252

Visit: airflow.com



Airflow Developments Limited
Aidelle House, Lancaster Road,
Cressex Business Park,
High Wycombe, Buckinghamshire,
United Kingdom, HP12 3QP

E-mail: info@airflow.com
Telephone: +44 (0) 1494 525252

airflow.com

© Airflow Developments Limited. Airflow Developments Limited reserve the right, in the interests of continuous development, to alter specifications without prior notice. All orders are accepted subject to our conditions of sale which are available on request



80001051 Issue 1 03/21